



CITY OF GRAND RAPIDS

Meeting Agenda Full Detail

City Council Work Session

Monday, November 25, 2013

4:15 PM

Conference Room 2A

CALL TO ORDER: Pursuant to due notice and call thereof a Special Meeting/Worksession of the Grand Rapids City Council was held on Monday, November 25, 2013 at 4:15 p.m. in Conference Room 2A, 420 North Pokegama Avenue, Grand Rapids, Minnesota.

CALL OF ROLL: On a call of roll, the following members were present:

Discussion Items

1. [13-0742](#) Earth Circle Presentation ~ Pat Helmberger
Attachments: [Earth Circle](#)

2. [13-0738](#) Crystal Lake Boulevard Project - Status Update
Attachments: [11-19-13 Presentation](#)

ADJOURN

ATTEST: TOM PAGEL, CITY ADMINISTRATOR

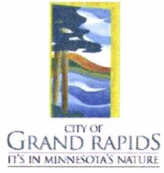

CITY OF GRAND RAPIDS

Legislation Details (With Text)

File #: 13-0742 **Version:** 1 **Name:** Earth Circle Presentation
Type: Agenda Item **Status:** CC Worksession
File created: 11/21/2013 **In control:** City Council Work Session
On agenda: 11/25/2013 **Final action:**
Title: Earth Circle Presentation ~ Pat Helmberger
Sponsors:
Indexes:
Code sections:
Attachments: [Earth Circle](#)

Date	Ver.	Action By	Action	Result
------	------	-----------	--------	--------

Earth Circle Presentation ~ Pat Helmberger





*Earth Circle of Grand Rapids Area invites people of faith
to join together to preserve and protect the Earth.*

*One area where we can all make a positive difference
is in reducing the one-time use of plastic bags!*







Earth Circle of Grand Rapids Area

We Need Your Help Because:

-  Plastic bags last forever
-  380 billion bags, sacks and wraps are used each year in the United States
-  Most are used once and discarded
-  Only a small number are recycled
-  1.6 billion gallons of oil are consumed each year producing them

How You Can Help:

-  Learn about plastic pollution
-  Purchase reusable bags at local stores
-  Take them with you when shopping
-  Wash them often
-  Recycle or reuse plastic bags and other plastic items

*I will do my best to remember to take my reusable bags
when I go shopping.*

**For more information, contact:
Pat at 326-6231 Vicki at 259-4254**

Creator God, you make all things and weave them together in an intricate tapestry of life. Teach us to respect the fragile balance of life and to care for all the gifts of your creation. Guide by your wisdom those who have power and authority that by the decisions they make, life may be cherished and a good and fruitful Earth may continue to show your glory and sing your praises.



You have called us to tend and keep the garden of your creation. Give us wisdom and reverence for all your plants and animals who share this planet with us and whose lives make possible our own. Help us to remember that they too love the sweetness of life and join with us in giving you praise.

National Council of Churches, Earth Day Resource Packet



Glance at the sun. See the moon and the stars. Gaze at the beauty of earth's greenings. Now think. What delight God gives to humans with all these things. All nature is at the disposal of humankind. We are to work with it. For without it we cannot survive.

Hildegard of Bingen – 12th century mystic

Children's Prayer for the Earth:

Dear God, thank you for this beautiful planet. Bless it and keep it safe from harm. We pray for the protection of the animals, the soil, air and water. May we care for all you have made. Help us to love this Earth as you do. We pray in Jesus' name. Amen



Carol Meyer in "National Catholic Reporter" 2/1/11



Earth Circle of Grand Rapids Area



Earth Circle of Grand Rapids Area

Please join us in reducing the one-time use of plastic bags!

We Need Your Help Because:



Plastic bags last forever



380 billion bags, sacks and wraps are used each year in the United States



Most are used once and discarded



Only a small number are recycled

1.6 billion gallons of oil are consumed each year producing them

How You Can Help:



Learn about plastic pollution



Purchase reusable bags at local stores



Take them with you when shopping



Wash them often



Recycle or reuse plastic bags and other plastic items

Earth Circle meets every first Tuesday of the month.

Please join us at Grand Rapids Library at 7PM

Paid for by Earth Circle of Grand Rapids Area

For info, call Pat at 326-6231



Earth Circle sub-committee promotes reusable bags

Earth Circle of the Grand Rapids area is eager to see more reusable bags around the community. In order to do that, it has formed a sub-committee to ask grocery and retail stores to support their efforts in encouraging shoppers to use reusable bags. Many Grand Rapids businesses already have such bags available at a minimal cost.

Plastic bags have become an environmental hazard. They are not biodegradable and last for hundreds, if not thousands, of years. The U. S. Environmental Protection Agency (EPA) states that 380 billion plastic bags, sacks, and wraps are produced each year. Most of them are used once and discarded. A miniscule amount is recycled.

A number of cities around the country have begun banning or reducing the use of plastic bags. San Francisco, Los Angeles, and Palo Alto, Calif.; Portland, Ore.; and Carbondale, Colo.

are just a few. Many nations around the world have done the same. Bangladesh banned plastic bags in 2002 after determining that the devastating floods of the late nineties were caused by plastic bags and other plastic throw-away items clogging the sewers and drains.

Ireland has a successful program, charging for plastic bags and nearly eliminating their use. African nations such as Rwanda, Tanzania, Uganda, and Kenya, along with cities in India, Pakistan, and Mexico have banned plastic bags. Earth Circle does not promote banning plastic bags but rather urges shoppers to carry their reusable bags with them.

Earth Circle meets monthly at the Grand Rapids Area Library. The next meeting is set for Tuesday, Sept. 3 at 7 p.m. The public is encouraged to participate and share their environmental concerns.

LETTER TO THE EDITOR

Changing shopping habits – good for Grand Rapids and the planet

The holiday season is upon us. Shoppers will be busily buying gifts, purchasing ingredients for Thanksgiving dinner and Christmas baking, and looking forward to family gatherings. It's a busy and exciting time of the year.

It's also a time when our consumption of plastic bags increases. Most of those bags will be thrown away and many of us will not think about them again. But, because plastic does not biodegrade, they will exist forever somewhere. Perhaps in a landfill, an ocean or river, or on the branches of a tree.

The Earth is ours to care for and we're not doing a very good job of it. There are many sources of pollution that we, as individuals, can do little about. Industrial exhaust and waste, water and air pollution from manufacturing, and oil pipeline spills are a few of them. But we can do something about plastic bags, one of the most prevalent sources of pollution. We literally hold them in our hands.

It's a simple matter of changing our habits. Most of us have a reusable bag or two but we often forget them at home or in our car when we shop. Some stores have a sign at their entry reminding us to bring them along and many Grand Rapids businesses sell reusable bags at a nominal cost. At least one store, Cub Foods, donated 500 bags to their shoppers in October. Many local business owners and managers are attempting to reduce the number of plastic bags consumed. But shoppers need to take responsibility to help.

Grand Rapids prides itself on being part of Minnesota's nature. We love our lakes, hiking and biking trails, and beautiful forests. We take pleasure in our clean streets and parks. Each of us can enhance our sense of community pride by reducing our consumption of plastic bags. They are a worldwide plague and many countries and states are doing something about it. Ireland stands out as a first-rate example. That country began charging for each plastic bag consumed and now has a 94 percent reduction in their use. Bangladesh banned plastic bags in 2002 after discovering that they plugged sewers and drains, contributing to the massive, deadly floods of the late 1990s.

Many cities and stores in the US have banned plastic bags. Los Angeles and San Francisco, Seattle, Carbondale and Aspen, Colo., and Portland, Ore., are a few that have taken action. But Minnesota has done little to combat this growing pollution source. Wouldn't be wonderful if Grand Rapids could stand as a model for the rest of the state?

We can do it by simply changing our habits. And habits can be changed. We do it all the time. It's a matter of thinking before we shop, of making sure our reusable bags are with us, and if we forget them in the car, being willing to go back and get them. If we do that, we'll change our habits after just a few trips back to the car, especially in the cold, and in the process, we'll be giving a gift to the Earth, to the businesses we depend upon, and to ourselves.

Pat Helmberger
Chair, Reusable Bag Sub-Committee
Earth Circle of Grand Rapids Area



COMMUNITY
FOUNDATION

GRAND RAPIDS AREA

**GRANT AGREEMENT BETWEEN
THE GRAND RAPIDS AREA COMMUNITY FOUNDATION
AND THE
EARTH CIRCLE
FROM THE FUND FOR THE ENVIRONMENT**

On October 28, 2013, the Grand Rapids Area Community Foundation (the Grantor) approved a grant for \$400 to the Earth Circle (Grantee) with the following stipulations:

1. The Grantee, Earth Circle, will use the grant for the specific purpose of providing support for: Reusable Bags and Use Your Bags Stickers.
2. Please feel free to publicize your award of this grant. The Community Foundation's logo is available electronically upon request. We request that when you publicize this award, you use wording that includes ... "*from the Fund for the Environment at the Grand Rapids Area Community Foundation*" ...
3. A monitoring report will be completed as soon as the funds are used, but no later than July 15, 2014. Monitoring Reports are submitted electronically through the Community Foundation's Grant Portal, accessed on the Grants & Programs page of our website at: www.gracf.org.

Please sign and return this letter as receipt of the above noted restrictions. If you have any questions or concerns regarding this grant, please do not hesitate to contact the Community Foundation at (218) 999-9100.

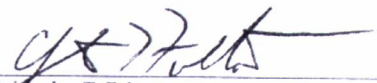

 Christopher T. Fulton,
 Executive Director Grand Rapids Area Community Foundation

10/30/2013

 Date

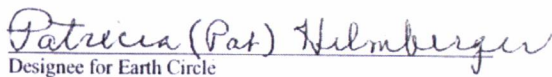

 Patricia (Pat) Hilmerger
 Designee for Earth Circle

Chair, Reusable Bag Comm.

 Title and Date
 11-4-13

Joining charitable intentions with community needs.

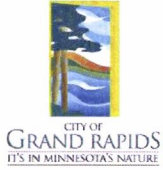

CITY OF GRAND RAPIDS

Legislation Details (With Text)

File #: 13-0738 **Version:** 1 **Name:** Crystal Lake Blvd Project - Status Update
Type: Agenda Item **Status:** CC Worksession
File created: 11/20/2013 **In control:** City Council Work Session
On agenda: 11/25/2013 **Final action:**
Title: Crystal Lake Boulevard Project - Status Update

Sponsors:

Indexes:

Code sections:

Attachments: [11-19-13 Presentation](#)

Date	Ver.	Action By	Action	Result
------	------	-----------	--------	--------

Crystal Lake Boulevard Project - Status Update

Background Information:

The information contained in the attached document was presented to the County Board at their work session on Tuesday, Nov. 19. The County Board unanimously supported the City continuing the project with Option 4, the roundabout.

Staff Recommendation:

Informational Purposes Only.



CITY OF
GRAND RAPIDS
IT'S IN MINNESOTA'S NATURE

Crystal Lake Boulevard

City Project 2011-2

Work Session

Itasca County Board Of Commissioners

November 19, 2013

Background – July Public Meeting

What We Heard

Conclusively: “**Something**” Needs To Be Done

Inconclusively: What Will “**Something**” Look Like

Consider the Differing Stakeholders’ Interests

- ❖ City Staff
- ❖ Commuters
- ❖ County Board
- ❖ Fairgrounds Vendors
- ❖ Neighborhood Residents
- ❖ School District

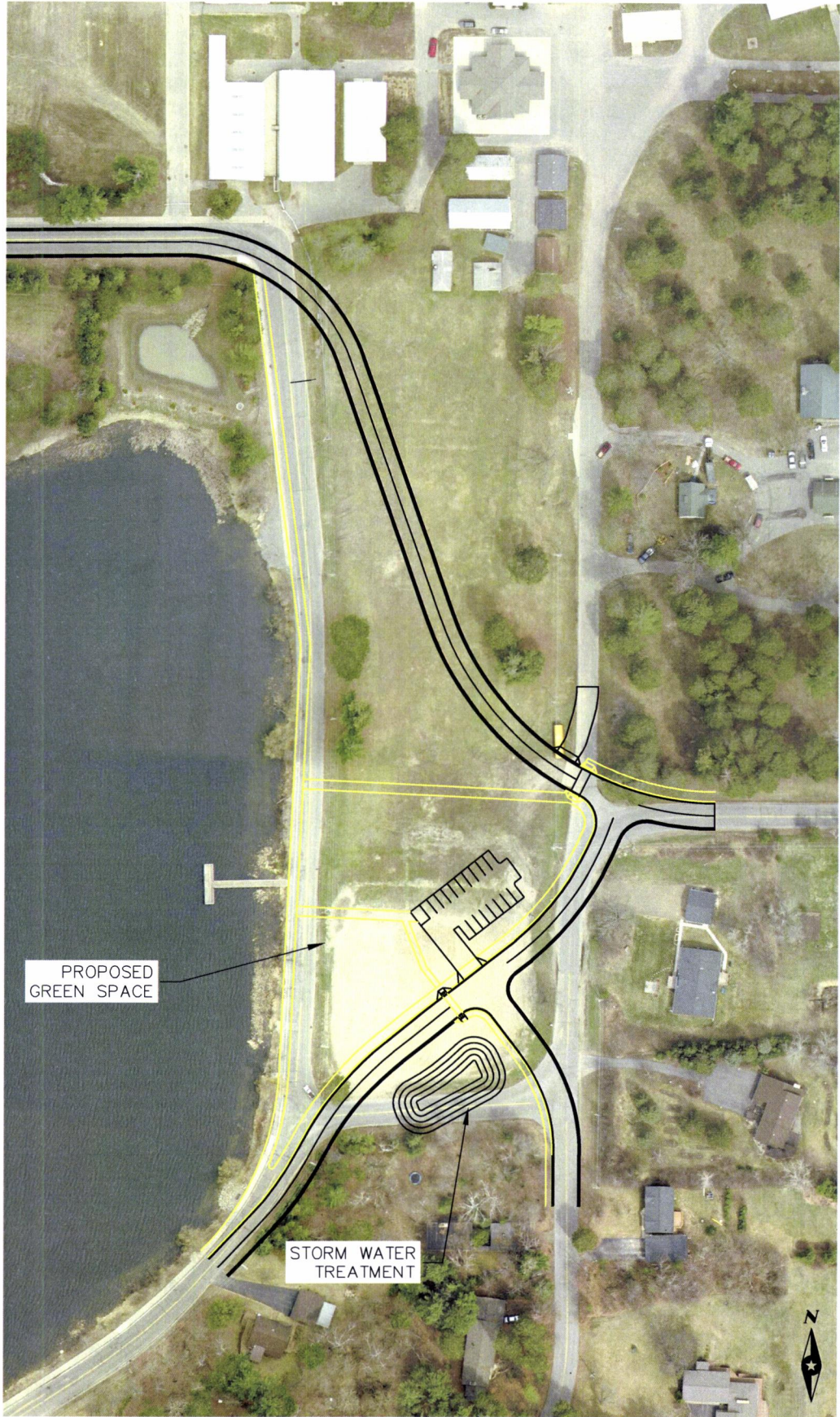

P:\A\G\GRANR\122012\5-10-13\drawings\10-Crystal Lake Boulevard\10-13\10-13.dwg 11/18/2013 3:56 PM mcspearth

PROPOSED GREEN SPACE

STORM WATER TREATMENT

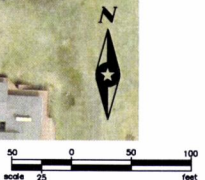

 <p>PHONE: 218 322 4500 21 NE 5TH ST STE 200 GRAND RAPIDS, MN 55744-2601 www.sehinc.com</p>	<p>FILE NO. GRANR 122012</p>	<p>OPTION 6 - ORIGINAL DESIGN CRYSTAL LAKE BOULEVARD IMPROVEMENTS GRAND RAPIDS, MINNESOTA</p>	<p>EXHIBIT</p>
	<p>DATE: 10/7/13</p>		

Background – October Public Meeting

What We Heard

Evaluated 5 new alignment options derived from the July meeting comments as well as over two dozen submitted ideas, sketches, and suggestions

Option 3 (north curve) and Option 4 (roundabout) were the most popular options considering all stakeholders comments and responses

The property owner (County) and the road authority (City) are furthering discussion of Option 4 as the most suitable option for all stakeholders

Section Along South Side Of Lake

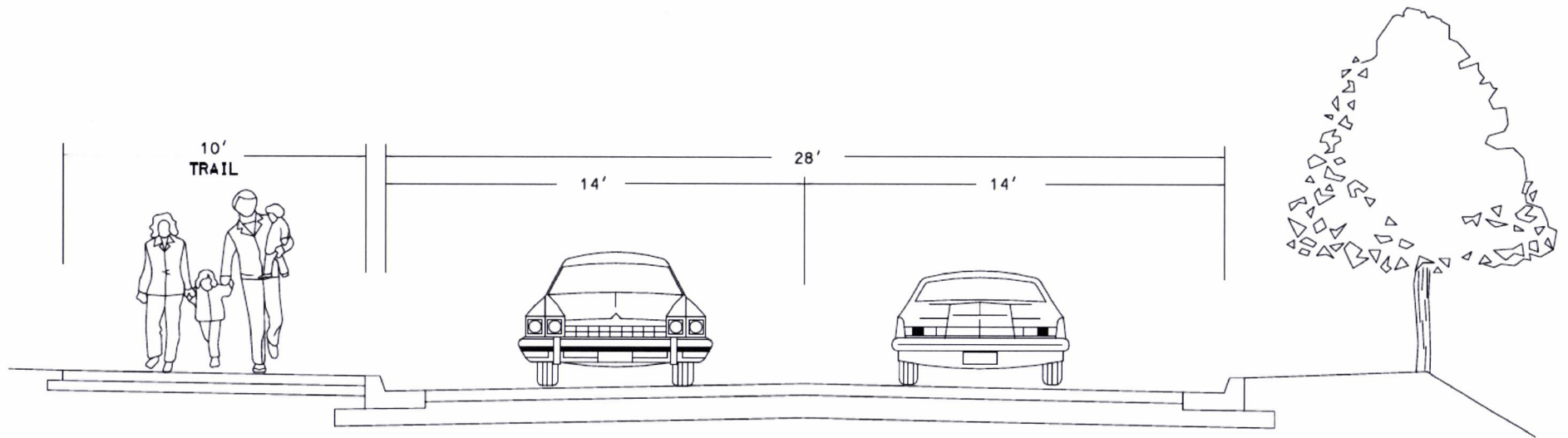

TYPICAL SECTION - TWO WAY
CRYSTAL LAKE BOULEVARD

Section Along Northeast Side Of Lake

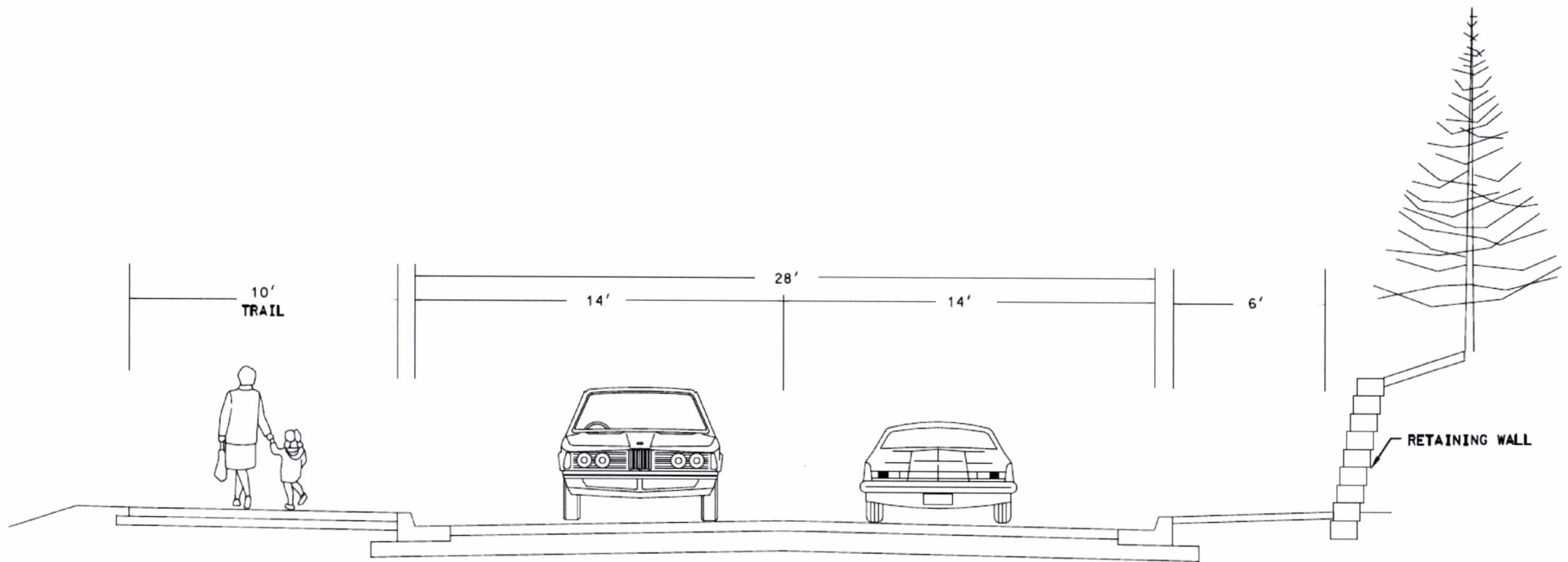

TYPICAL SECTION - TWO WAY
WITH RETAINING WALL
CRYSTAL LAKE BOULEVARD

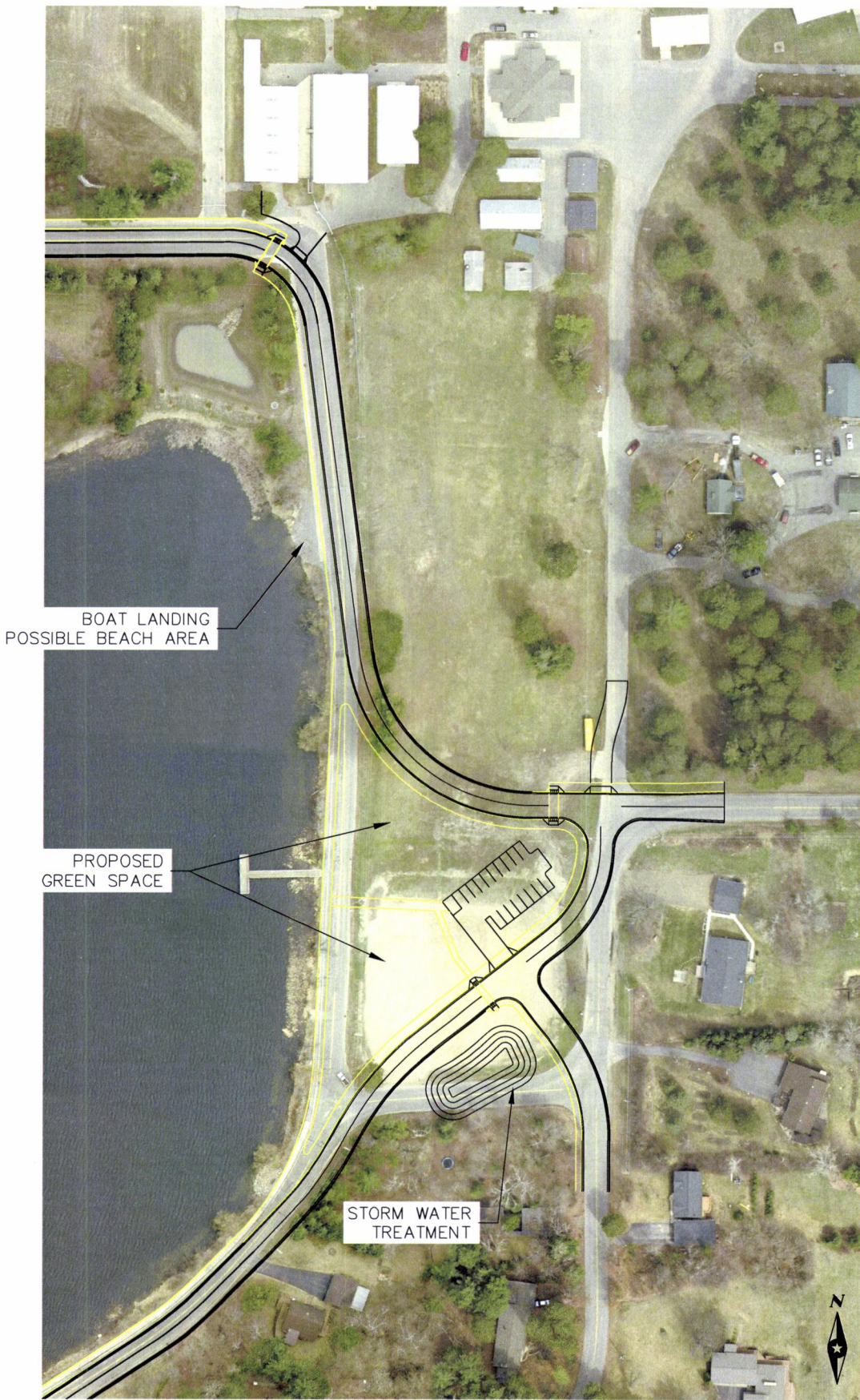

P:\CA\GRANDR\122012\3- final-dsgn\51- dswmpa\51- dswmpa\10- Cell\Load\Map\Options\BRT22012_ Exhibits.dwg 10/28/2013 10:42 AM mswayw@fh

SEH
 PHONE: 218.322.4500
 21 NE 5TH ST STE 200
 GRAND RAPIDS, MN 55744-2601
 www.sehinc.com

FILE NO.
 GRANR 122012
 DATE:
 10/7/13

**OPTION 3 - RIDGEWOOD EXTENSION
 CRYSTAL LAKE BOULEVARD
 IMPROVEMENTS
 GRAND RAPIDS, MINNESOTA**

**EXHIBIT
 NO. 3**

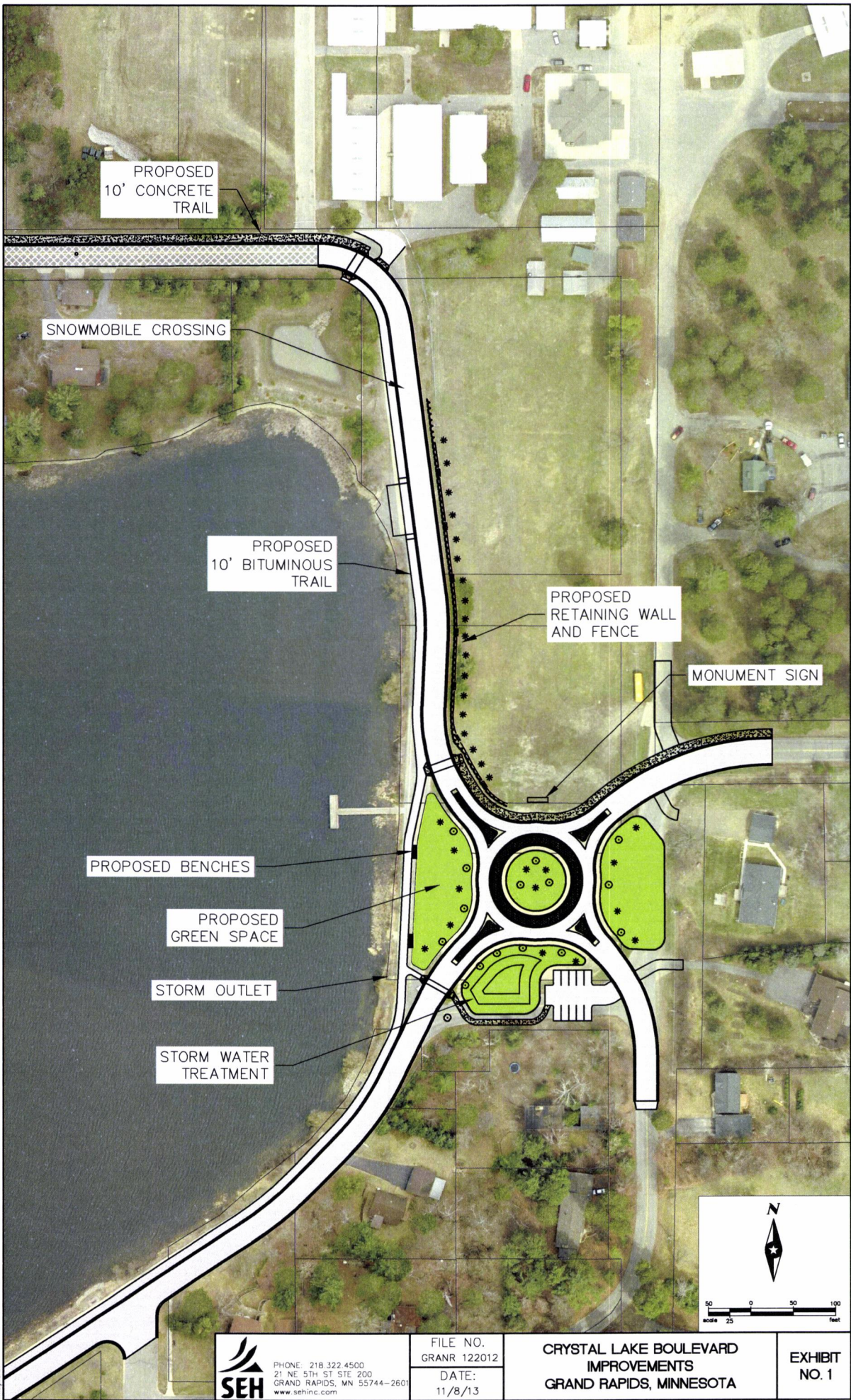

P:\EAG\GRAND\122012\5-inr-dsgn\51-dwgn\51-dwgn.dwg (User: jg) 11/19/2013 11:25 AM
 magaw@h

 PHONE: 218.322.4500
 21 NE 5TH ST STE 200
 GRAND RAPIDS, MN 55744-2601
 www.sehinc.com

FILE NO.
 GRANR 122012
 DATE:
 11/8/13

**CRYSTAL LAKE BOULEVARD
 IMPROVEMENTS
 GRAND RAPIDS, MINNESOTA**

**EXHIBIT
 NO. 1**

Next Steps - Schedule

August 2014

SUNDAY	MONDAY	TUESDAY	WEDNESDAY	THURSDAY	FRIDAY	SATURDAY
					1	2 •Fair Grounds Mesabi Bike Tour
3	4	5	6	7 •Race Night	8 Final Project Completed	9
10	11	12	13 •Fair Grounds County Fair 12PM-12AM	14 •Race Night •Fair Grounds County Fair 12PM-12AM	15 •Fair Grounds County Fair 12PM-12AM	16 •Fair Grounds County Fair 12PM-12AM
17 •Fair Grounds County Fair 12PM-12AM	18	19	20	21 •Race Night	22	23
24	25	26	27	28 •Race Night	29	30 31

July 2014

SUNDAY	MONDAY	TUESDAY	WEDNESDAY	THURSDAY	FRIDAY	SATURDAY
		1	2	3 •Race Night Phase 1 Substantially Complete	4 •Holiday	5
6	7	8	9	10 •Race Night	11	12
13	14	15	16	17 •Race Night	18	19
20	21	22	23	24 •Race Night	25 Phase 2 Substantially Complete	26 •Fair Grounds Vintage Car Club Show
27 •Fair Grounds Vintage Car Club Show	28	29	30	31 •Race Night		

June 2014

SUNDAY	MONDAY	TUESDAY	WEDNESDAY	THURSDAY	FRIDAY	SATURDAY
1	2	3	4	5 •Race Night	6	7 •Fair Grounds Saddle Club Horse Show
8 •Fair Grounds Saddle Club Horse Show	9	10	11	12 •Race Night	13 •FairGrounds, Campground, Fine Arts Building Bluegrass Festival	14 •FairGrounds, Campground, Fine Arts Building Bluegrass Festival
15 •FairGrounds, Campground, Fine Arts Building Bluegrass Festival	16 Phase 2 Start	17	18	19 •Race Night	20	21
22	23	24	25	26 •Race Night	27	28 •Fair Grounds 4-H Horse Clinic
29 •Fair Grounds 4-H Horse Clinic	30					

May 2014

SUNDAY	MONDAY	TUESDAY	WEDNESDAY	THURSDAY	FRIDAY	SATURDAY
				1	2	3
4	5	6	7	8 •Open Bids	9	10 •MN Fishing Opener
11	12 •Council Awards Project	13	14	15 •Race Pit Opens (Assumed) 4:00 PM	16	17 •Road weight restrictions are removed
18	19 •Hold Preconstruction Meeting	20 •Start Construction	21	22 •Race Night	23	24
25	26 •Holiday	27	28	29 •ISD 318 Last Day of School •Race Night	30	31

April 2014

SUNDAY	MONDAY	TUESDAY	WEDNESDAY	THURSDAY	FRIDAY	SATURDAY
		1	2	3	4	5
6	7	8	9	10	11	12
13	14 <i>Council approves plans and city authorizes bidding</i>	15	16 <i>Advertise - Herald</i>	17	18	19
20	21	22	23 <i>Advertise - Herald</i>	24	25	26
27	28	29	30			

March 2014

SUNDAY	MONDAY	TUESDAY	WEDNESDAY	THURSDAY	FRIDAY	SATURDAY
						1
2	3	4	5	6	7	8
9	10	11	12	13	14	15
16	17	18	19	20	21	22
23	24	25	26	27	28	29
30	31					

Feb 2014

SUNDAY	MONDAY	TUESDAY	WEDNESDAY	THURSDAY	FRIDAY	SATURDAY
						1
2	3	4	5	6	7	8
9	10 Council holds public hearing and authorizes preparation of plans/specs	11	12	13	14	15
16	17	18	19	20	21	22
23	24	25	26	27	28	

January 2014

SUNDAY	MONDAY	TUESDAY	WEDNESDAY	THURSDAY	FRIDAY	SATURDAY
			1	2	3	4
5	6	7	8	9	10	11
12	13	14	15	16	17	18
19	20	21	22	23	24	25
26	27 Council Accepts feasibility and orders public hearing	28	29	30	31	

December 2013

SUNDAY	MONDAY	TUESDAY	WEDNESDAY	THURSDAY	FRIDAY	SATURDAY
1	2	3	4	5	6	7
8	9	10	11	12	13	14
15	16	17	18	19	20	21
22	23	24	25	26	27	28
29	30	31				

Request for Consideration

Consensus that Option 4 is acceptable in concept so that City Staff may begin working with County Staff on the Right-Of-Way & Easement documents so that they may be brought before the Council and Board in late December or early January.

Thank you!

Questions & Comments...